

I. Lifetime Estimation

Subject series : FR/FH/FG/FF/FS/FL/FT/FP/VB/VP/VS

Conductive polymer aluminum solid capacitors are finite life electronic components like aluminum electrolytic capacitors. The lifetime is affected by ambient temperature, humidity, ripple current and surge voltage.

The lifetime of aluminum electrolytic capacitors is affected mainly by the loss of electrolyte as the result of the liquid electrolyte evaporating through the rubber seal materials, resulting in capacitance drop and tanδ rise. On the other hand, the lifetime of conductive polymer aluminum solid capacitors is affected mainly by oxidation degradation of the conductive polymer caused by osmose of oxygen or the thermal degradation of the conductive polymer by ambient temperature or self-heating, resulting in ESR rise and tanδ rise. The infiltration rate of the oxygen is depend on the temperature as the liquid electrolyte evaporation and the relationship follows the Arrhenius's Law, too. Similarly, thermal degradation of the conductive polymer by self-heating follows the Arrhenius's Law, too. Therefore, the lifetime estimation has been using the theory of lifetime increasing by 10 times at every 20°C reducing of the ambient temperature.

1. Lifetime Estimation

Equation (1) can be used for estimating the lifetime of the conductive polymer aluminum solid capacitors based on the ambient temperature and the rise of internal temperature due to ripple current.

$$L_x = L_0 \times 10^{(T_0 - T_x)/20} \text{-----(1)}$$

Lx : Estimation of actual lifetime (hour)

Lo : Specified lifetime with the rated voltage at the upper limit of the category temperature (hour)

To : Maximum category temperature (°C)

Tx : Actual ambient temperature of the capacitor (°C)

Longer lifetime is expected by lowering the ripple current and the ambient temperature.

Please consult us about lifetime equations for the series of the category temperature 125°C.

Subject series : FT

An approximate value of ripple current-caused ΔT can be calculated using Equation (2)

$$\Delta T = \Delta T_0 \times (I_x / I_0)^2 \text{-----(2)}$$

ΔT₀ : Rise in internal temperature due to the rated ripple current (20°C) The product that the maximum category temperature is less than 105°C

I_x : Operating ripple current (Arms) actually flowing in the capacitor

I₀ : Rated ripple current (Arms), frequency compensated, at the upper limit of the category temperature range

Please contact us about the product that the maximum category temperature is more than 125°C.

To determine more accurate values of ΔT, they can be actually measured using a thermocouple.

2. Rated Ripple Current Frequency Multipliers

Self-heat rise is generated by the ripple current even though the conductive polymer aluminum solid capacitors have low ESR compared to liquid based electrolyte aluminum electrolytic capacitor. Longer lifetime is expected by lowering the ripple current and the ambient temperature. Table 1 shows Frequency Multipliers of Rated ripple current.

Frequency Multipliers

Frequency [Hz]	120	1k	10k	50k	100k~500k
SMD type	0.05	0.3	0.55	0.7	1
Radial lead type	0.1	0.35	0.6	0.8	1

Conductive polymer aluminum solid capacitors have super low ESR characteristic in high-frequency range. On the whole, ESR in low-frequency range relatively rises. Therefore, they can use only 1 ripple current in low-frequency range.

3. Restriction of calculated lifetime

- (1) The result calculated by the estimated lifetime formula, it is not guaranteed lifetime by Nippon Chemi-Con Corporation.
- (2) When designer calculate the lifetime of apparatus, please include an ample margin in consideration to the estimated lifetime of a capacitor.
- (3) When calculated lifetime result are over 15 years by using the estimated lifetime formula, please consider 15 years to be a maximum in considering that the sealing rubber characteristics vary during the lifetime.
- (4) If 15 years or more may be required as an expected lifetime, please consult us.

II. About failure and shelf-life

Failure rate (failure rate level) subject to 0.5 %/1000 h of JIS C 5003 (Credibility level 60 %)

The main failure mode of polymer solid aluminum electrolytic capacitor of is shown below.

1. Random failure

The main cause of failure mold is short-circuit due to heat stress, electrical stressing and mechanical stress in using environment or welding.

- (1) applied voltage more than rated voltage
- (2) applied reverse voltage
- (3) Excessive mechanical stress
- (4) Applying fast charging and discharging that more than specifications and cause surge current

a. If the short circuit current flows through the solid capacitor will cause the following phenomenon.

- (1) When the electric current is less after short-circuit (φ10 : about below 1 A , φ8 : about below 0.5 A , φ6.3 : about below 0.2 A) PC-CON body will have little heat but appearance is normal even continuous electricity.

(2) When the short circuit current value exceeds the above numerical, internal temperature will increased, encapsulation adhesive pad summoned and the odorous gases to overflow.

b. In order to ensure the safety in case of occurs short circuit, please take the following countermeasures

- (1) Cut off the main power supply and stop using immediately if overflow the odorous gases.
- (2) Due to the different conditions , the odorous gases occurrence generally takes a few seconds to several minutes, When using protection circuits we recommend to start protect function in this period.
- (3) Cleaned immediately if the gas enters into eye · gargle immediately if inhalation into mouth.
- (4) Don't lick the electrolyte if electrolyte contact with the skin please washing with soap immediately.
- (5) PC - CON including combustibile material, current value greatly after the short circuit and short circuit parts will have a possibility of spark. In order to protect safety, please pay attention to the design structure and use protection circuit.

2. The wear failure (Shelf life)

Electrical characteristics can make a big change when more than the guarantee time of durability and high temperature and high humidity test, electrolyte will insulation (degradation) formation of open mode eventually.

Even used within the prescribed scope of electrical and mechanical properties, it may also reducing capacitance and increase ESR, so please take care when design.

III. Leak Current

The leak current of conductive polymer solid aluminum electrolytic capacitor will increase due to the mechanical stress .

In this case, if the solid capacitor apply voltage below the high using temperature, the repairing effect of leak current will reducing gradually.

If the solid capacitor applies rated voltage within the high using temperature, the repairing speed of leak current will faster.

Conductive polymer solid aluminum electrolytic capacitor
Repairing character of leak current
10μF/16 V.DC (apply 16 V.DC)

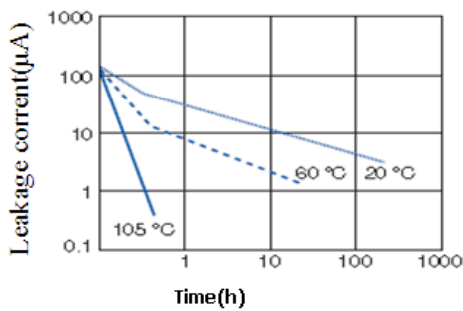

Conductive polymer solid aluminum electrolytic capacitor
Repairing character of leak current
33μF/10 V.DC (ambient temperature65°C)
(Test voltage10V.DC)

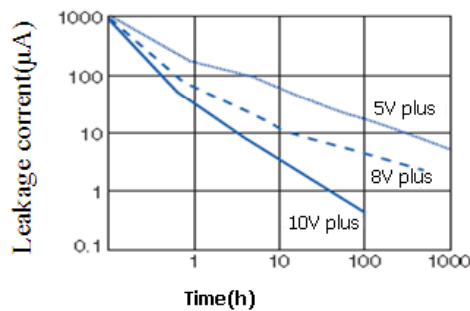

※In order to show more clearly said repair of leakage current , we use the sample of apply stress to PC-CON that increased leak current on puri

IV.The limited of faster charging and discharging

Faster charging and discharging will lead to large surge current and then result in short-circuit or increase leak current.

When the surge current value as below, we recommend to use protection circuit in order to maintain high reliability.

- (1) more than 10 A
- (2) exceed rated ripple current 10times

V. Correct mounting

1. About the soldering iron soldering

- (a) Avoiding applying stress on PC - CON body when it need to process lead due to unconformity between lead gap and circuit board gap of plug-in mounting.
- (b) Avoiding applying excessive stress on PC - CON body when soldering.
- (c) When need to take out PC-CON after soldering, please melt molten solder sufficient, implement under the condition of not put stress on the PC - CON body.
- (d) Don't let the tip of the soldering iron to touch the PC - CON body.

2. Wave-soldering

- (a) Do not have wave soldering to SMD product.
- (b) Do not dip the PC-CON body into dissolved soldering flux.
- (c) Welding parts only limited between the circuit board and the opposite side of the PC - CON.
- (d) Don't splash other place expectation rosin.
- (e) Avoiding other parts lie down and touching PC-CON when soldering.

3. Reflow soldering

- (a) Do not have reflow soldeering to plug-in mounting product .
- (b) Please consult us when use VPS for solderinig.

4. Precaution after soldering

Take care for not to apply the following excessive stress for polymer solid aluminum electrolytic capacitor.

- (a) Do not tilt down or distorted capacitor.
- (b) Mobile circuit board can not handle PC - CON.
- (c) Do not crash PC-CON.
- (d) Do not make the PC - CON touch PCB circuit boards and other components when stacked.

5. Recommended conditions for solder

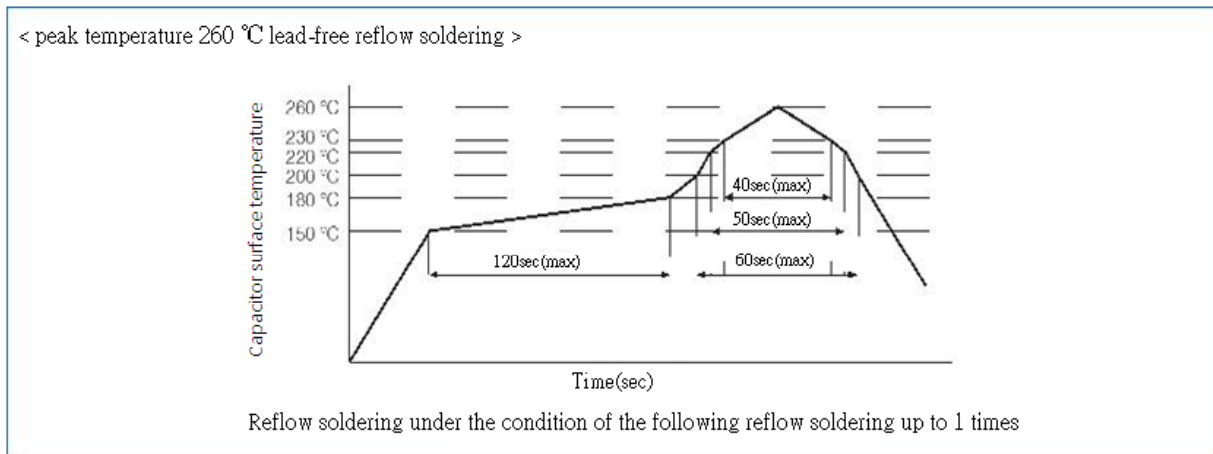
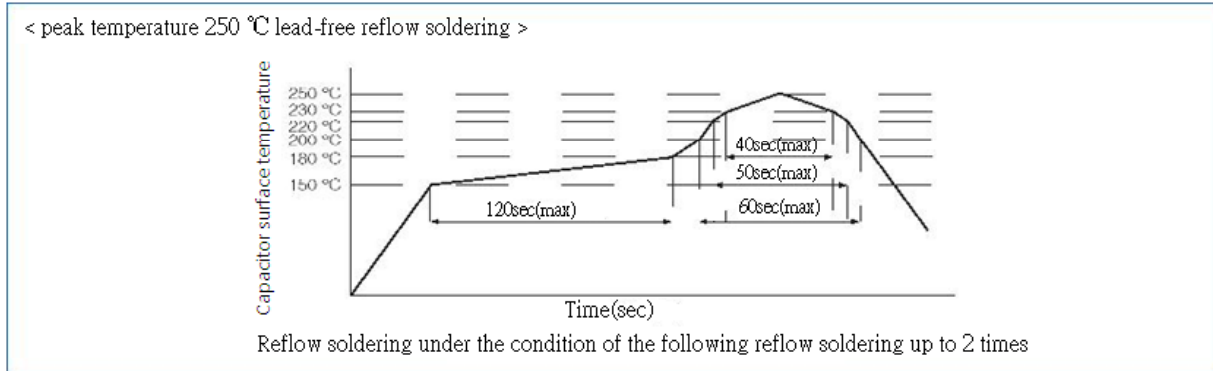

6. Solder iron temperature : less than 400°C±10°C ; working hours : within 5s

Wave-soldering

	Temperature	Time	Number of Time
Preheat	120°C below (ambient temperature)	less than 120s	once
Welding Condition	260°C+ 5°C below	less than 10+ 1s	less than twice*1

*1 : For 2 times, solder dipping time total of 10 + 1 seconds.

7. Recommend the bonding pad size

Unit : mm

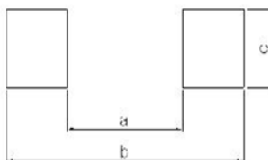

Size Code	a	b	c
φ5.0	1.4	7.4	1.6
φ6.3	2.1	9.1	1.6
φ8.0	2.8	11.1	1.9
φ10.0	4.3	13.1	1.9

1 . Overview of Aluminum Electrolytic Capacitors

1-1 Basic Model of Aluminum Electrolytic Capacitors

1) Capacitors are passive components. Among the various kinds of capacitors, aluminum electrolytic capacitors offer larger CV product per case size and lower cost than the others. In principles of capacitor, its fundamental model is shown in Fig.1 and its capacitance © is expressed by Equation (1) below:

$$C = 8.854 \times 10^{-12} \epsilon S (F) \dots\dots\dots (1)$$

- ε : Dielectric constant
- S : Surface area of dielectric (m²)
- d : Thickness of dielectric (m)

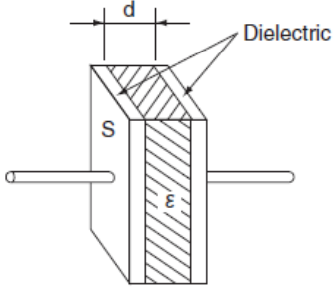

Fig-1 Basic model of capacitor

2) Equation (1) shows that the capacitance (C) increases as the dielectric constant (ε) and/or its surface area (S) increases and/or the dielectric thickness (d) decreases.

An aluminum electrolytic capacitor comprises a dielectric layer of aluminum oxide (Al₂O₃), the dielectric constant (ε) of which is 8 to 10. This value is not significantly larger than those of other types of capacitors

However, by extending the surface area (S) of the aluminum foil electrode by means of etching, and by electrochemically forming a thinner but highly voltage-withstandable layer of oxide layer dielectric, the aluminum electrolytic capacitor can offer a larger CV product per case than other types of capacitors.

3) A basic model of aluminum electrolytic capacitor is shown in Fig. 2.

An aluminum electrolytic capacitor comprises

- Anode ...Aluminum foil
- Dielectric...Electrochemically formed oxide layer (Al₂O₃) on the anode
- Cathode ...A true cathode is electrolytic solution (electrolyte).

Other component materials include a paper separator that holds electrolyte in place and another aluminum foil that functions as a draw-out electrode coming into contact with the true cathode (electrolyte). In general, an aluminum electrolytic capacitor is asymmetrical in structure and polarized. The other capacitor type known as a bi-polar (non-polar) comprises the anodic aluminum foils for both electrodes.

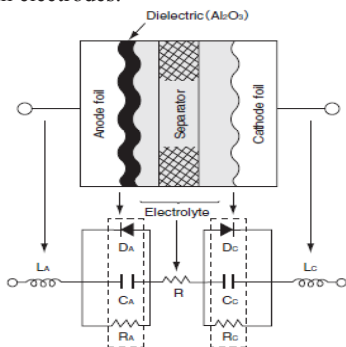

Fig-2 Basic model and equivalent circuit aluminum electrolytic capacitor

- CA, CC : Capacitance due to anode and cathode foils
- DA, DC : Diode effects due to oxide layer on anode and cathode foils
- L : Inductance due to anode and cathode terminals
- R : Resistance of electrolyte and separator
- RA, RC : Internal resistance of oxide layer on anode and cathode foils.

1-2 Structure of Aluminum Electrolytic Capacitor

1) The aluminum electrolytic capacitor has, as shown in Fig. 3, a roll of anode foil, paper separator, cathode foil and electrode terminals (internal and external terminals) with the electrolyte impregnated, which is sealed in an aluminum can case with a sealing material. The terminal draw-out structure, sealing material and structure

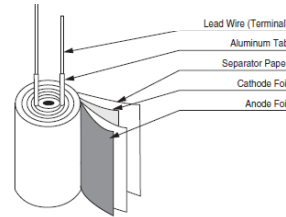

Fig-3 Basic model of element

2) The terminal draw-out structure, sealing material and structure differ depending on the type of the capacitor. Figure 4 shows typical examples.

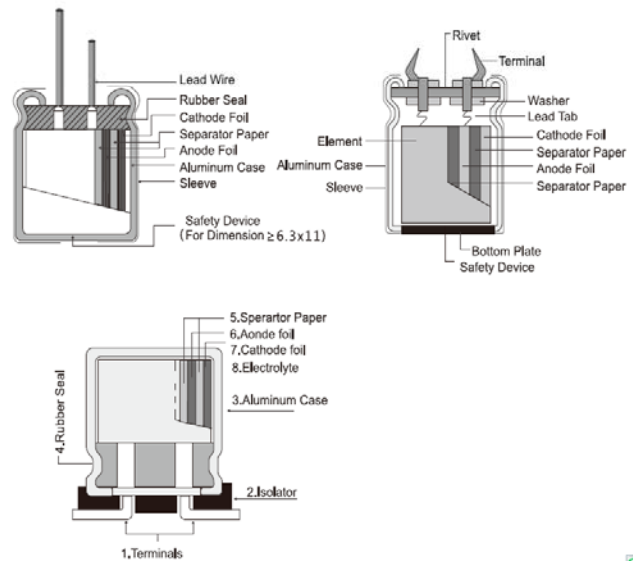

Fig-4 Construction of Aluminum Electrolytic Capacitors

1-3 Features of Capacitor Materials

Aluminum, which is main material in an aluminum electrolytic capacitor, forms an oxide layer (Al₂O₃) on its surface when the aluminum is set as anode and charged with electricity in electrolyte. The aluminum foil with an oxide layer formed thereon, as shown in Fig. 5, is capable of rectifying electric current in electrolyte. Such a metal is called a valve metal.

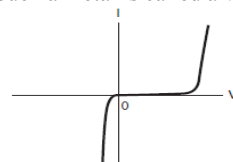

Fig-5 V-I characteristics of aluminum oxide

TEAPO Proper Usage Methods of Liquid Aluminum Electrolytic Capacitor

<Anode aluminum foil>

First, the foil material is electromechanically etched in a chloride solution to extend the surface area of the foil. Secondly, for the foil to form an aluminum oxide layer (Al_2O_3) as a dielectric, more than the rated voltage is applied to the foil in a solution such as ammonium borate. This dielectric layer is as dense and thin as 1.1 - 1.5 nm/volt and showing a high insulation resistance (108 - 109 Ω/m). The thickness of the oxide layer determines withstand voltage according to their direct proportional relationship. For the etching pits to be shaped to the intended thickness of the oxide, the pit patterns have been designed to have efficient surface area extension depending on the intended withstand voltage (see Fig. 6)

<Cathode aluminum foil>

An etching process is performed to the cathode aluminum foil as well as the anode foil. However, the formation process for oxide layer is generally not performed. Therefore, the surface of the cathode foil only has an oxide layer (Al_2O_3) that has spontaneously formed, which gives a withstand voltage of about 0.5 volt

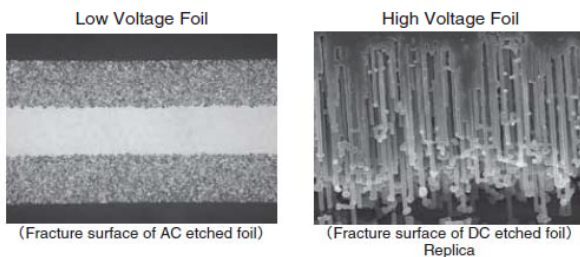

Fig-6 Cross section of aluminum etched foil (SEM)

<Electrolyte>

The electrolyte, an ion-conductive liquid functions as a true coming into contact with the dielectric layer on the surface of the foil. The cathode foil serves as a collector electrode to connect the cathode with the external circuit. Electrolyte is an essential controls the performance of the capacitor (temperature frequency characteristics, service life, etc.).

<Paper separator >

The separator maintains uniform distribution of the electrolyte and keeps the anode-to-cathode foil distance unchanged.

<Can case and sealing materials>

An aluminum can case and seal materials mainly consisting of rubber are used for the purpose of keeping airtightness.

1-4 Manufacturing Process

① Etching (for extending the surface area)

This etching process serves to extend the surface area of the foil. This is an AC or DC current-employed electrochemical process for etching the foil surface in a chloride solution (see Fig. 7)

② Formation (for forming a dielectric)

This is a process for forming a dielectric layer (Al_2O_3), which is normally performed on the anode aluminum foil. (see Fig. 8)

③ Slitting

This is a process for slitting aluminum foils (both the anode and cathode) and separator paper to the specified product size. (see Fig. 9)

④ Winding

This is a process for rolling a set of anode and cathode foils into a cylindrical form with a paper separator inserted between them. During this process, an inner terminal (called a tab) is attached to each of the aluminum foils. The roll made at this process is called a capacitor element.

⑤ Impregnation

This is a process for impregnating the element with electrolyte as a true cathode. The electrolyte also functions to repair the dielectric layer. (see Fig. 11)

⑥ Sealing

This process seals the element using the aluminum can case and sealing materials (rubber, rubber-lined cover, etc.) for keeping the case airtight. (see Fig. 12)

⑦ Aging (reforming)

The process of applying voltage to a post-sealed capacitor at high temperature is called "aging". This serves to repair defective dielectrics that have been made on the foil during the slitting or winding process.

⑧ 100% inspection and packaging

After the aging, all products shall undergo testing for checking their electrical characteristics with chip termination, lead reforming, taping etc. finished, and then be packaged.

⑨ Outgoing inspections

Outgoing inspections are performed as per standard inspection procedures.

⑩ Shipment

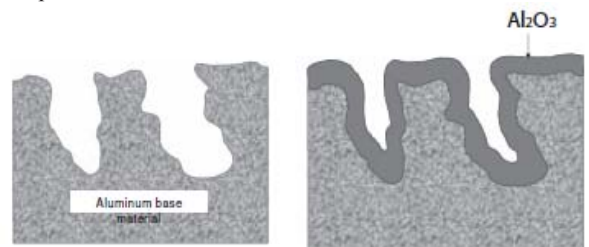

see Fig. 7 Etching Model

see Fig. 8 Forming Model



see Fig. 9 Slitting Model

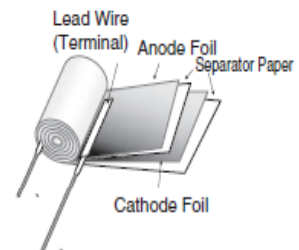

see Fig. 10 Cathode Foil

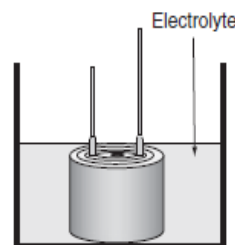

see Fig. 11 Impregnation

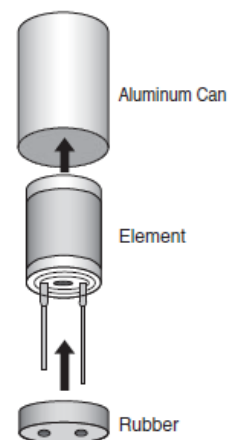

see Fig. 12

2 . Basic Performance

2-1 Basic Electrical Characteristics

2-1-1 Capacitance

The larger the surface area of an electrode is, the higher the capacitance (capacity for storing electricity) is. For aluminum electrolytic capacitors, capacitance is measured under the standard of 20°C and a 120Hz AC signal of about 0.5V. Generally, as the temperature rises, the capacitance increases; as the temperature decreases, the capacitance decreases (Fig. 13). With a higher frequency, the capacitance is smaller; with a lower frequency, the capacitance is larger (Fig. 14).

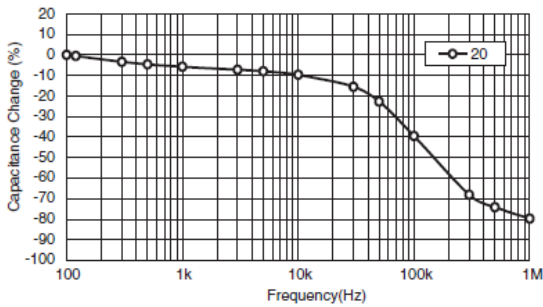
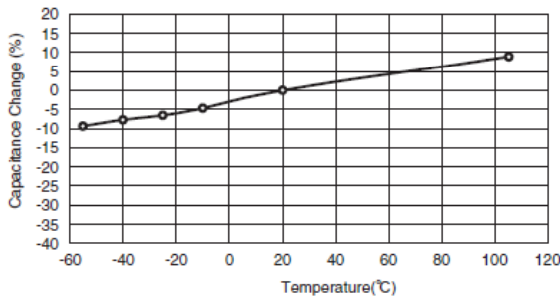

Fig-14 Frequency Characteristics of Capacitance

2-1-2 Tanδ (also called tangent of loss angle or dissipation factor)

(Fig. 15) is a simplified model of the equivalent circuit shown in (F). For an ideal capacitor with an equivalent series resistance of R = 0, the tanδ shown in (Fig. 10) is zero. For an aluminum electrolytic capacitor, the equivalent series resistance (R) is not zero due to the presence of resistance of the electrolyte and paper separator and other contact resistances. 1/ωC and R are correlated as shown in (Fig. 16) and Equation (2).

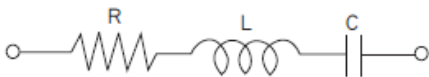

Fig-15 Simplified equivalent circuit

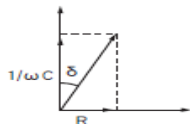

Fig-16 Dissipation Factor (tanδ)

$$\tan \delta = \frac{R}{1/\omega C} = \omega CR \dots\dots\dots (2)$$

$\omega : 2 \pi f$

π = Circular constant, f : Frequency (f = 120Hz)

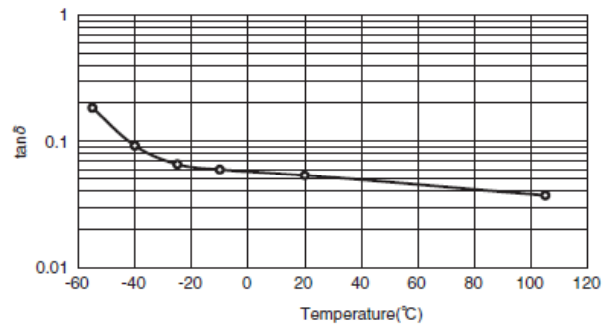

Fig-17 Temperature Characteristics of tanδ

2-1-3 Leakage Current (LC)

① As a feature of an aluminum electrolytic capacitor, when DC voltage is applied to it, the oxide layer that acts as a dielectric in the electrolyte allows a small amount of electric current to flow in it. The small amount

of current is called a leakage current (LC). An ideal capacitor does not allow the leakage current to flow (this is not the case for charging current).

② The leakage current (LC) changes with time as shown in (Fig. 18) value. Therefore, the specifications of LC are defined as a value of the rated voltage at 20°C. As the temperature rises, the LC increases; as the temperature decreases, the LC decreases (Fig. 19). As the applied voltage decreases, the LC decreases.

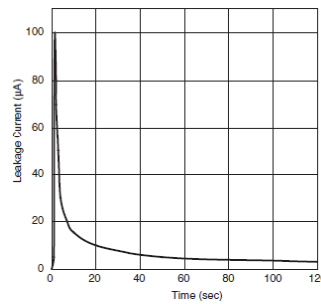

Fig-18 Leakage Current vs. Time

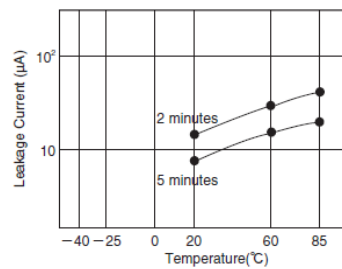

Fig-19 Temperature Characteristics of Leakage Current

2-2 Frequency Characteristics of Impedance (Z)

① When a capacitor is applied with a voltage with the frequency changed, the impedance (Z), a factor of preventing the AC current changes as shown in (Fig. 14). This is the impedance-frequency characteristics of the capacitor.

② (Fig. 15) is a simplified model of an equivalent circuit of an aluminum electrolyte capacitor. (Fig. 20) shows dotted lines representing a breakdown of the impedance-frequency characteristic curve into components (C, R and L). As can be seen in this figure, the impedance-frequency characteristics are a composition of C, R and L frequency characteristics.

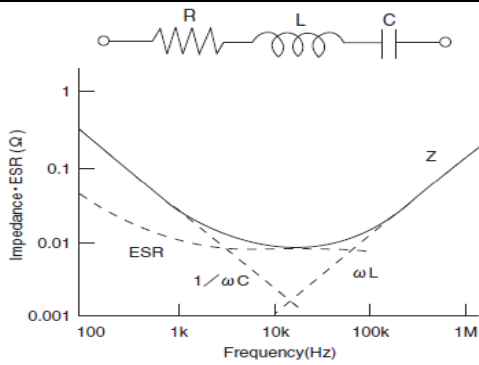

Fig-20 Factor of Impedance Frequency

③The value $1/\omega C$ shows the pure capacitive reactance graphically presented by a straight line going downward at an angle of 45° , and ωL shows the pure inductive reactance graphically presented by a straight line going upward at 45° . R shows the equivalent series resistance (ESR). At a range of lower frequencies, the R curve goes downward due to the dielectric loss frequency-dependence. At a range of higher frequencies, the R curve tends to be almost flat since resistance of electro-lyte and paper separator is dominant and independent on frequency. Equation (3) shows this tendency.

$$Z = \sqrt{R^2 + \left(\omega L - \frac{1}{\omega C}\right)^2} \dots\dots\dots (3)$$

④Because the impedance characteristics of an aluminum electrolyte capacitor depend on resistance of the electrolyte and paper separator, the Z value at the self-resonant frequency tends to be shown by the solid line in (Fig.21). The resistance of the electrolyte varies depending on temperature: as the temperature rises, the impedance decreases; and as the temperature decreases, the impedance increases, as shown in (Fig. 22).

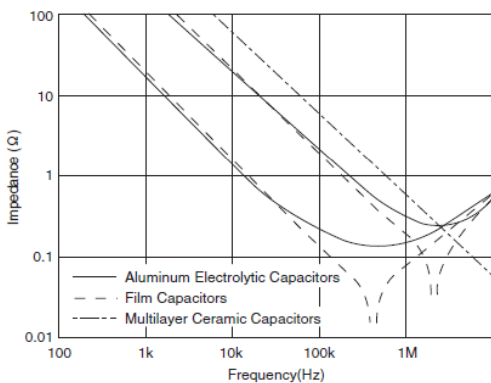

Fig-21 Frequency Characteristics of each Capacitors Impedance

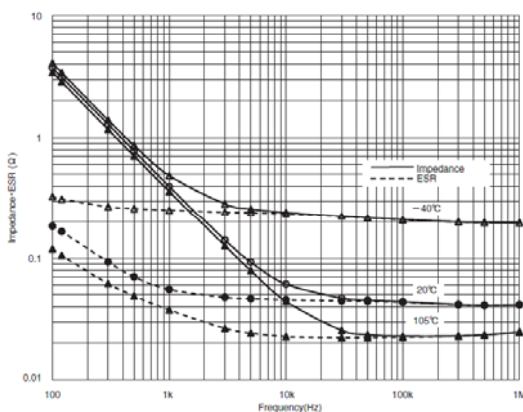

Fig-22 Temperature and Frequency Characteristics of Impedance · ESR

3 . Reliability

For designing the device with aluminum electrolytic capacitors, a failure rate and useful life are necessary to be considered for their reliability. The failure rate of aluminum electrolytic capacitors is approximated by the bathtub curve shown in (Fig.23).

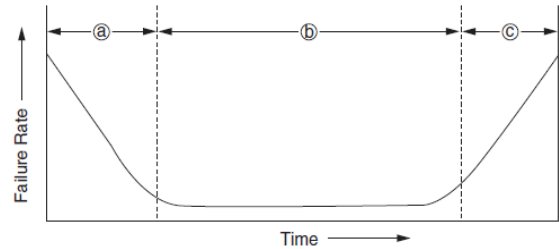

Fig-23 Bathtub curve

- a Early failure period
At the comparatively early periods of use, devices/components fail by deficiencies in design or manufacturing process or incompatibility with operation conditions. For aluminum electrolytic capacitors, these defectives are removed by debugging at one of manufacturing processes before shipments.
- b Random failure period
Failure is stable low in occurrence and appears unrelated to their served term. Aluminum electrolytic capacitors are low in failures in this period compared with semi-conductors and solid tantalum capacitors.
- c Wear-out failure period
In this period, the failure rate increases with the served time. For aluminum electrolytic capacitors, since they were completed in manufacturing, the electrolyte impregnated has gradually evaporated and diffused out of the capacitors through the rubber seal materials with time, which leads to decrease in the capacitance and/or increase $\tan\delta$. When any of these values changes beyond the allowable range of specifications, the capacitors are defined as “fell into the wear-out failure”. The served term until the capacitors fall into the wear-out failure period is called a useful life.

4 . Failure Modes

Aluminum electrolytic capacitors have two categories of failures catastrophic failure and wear-out failure.

<Catastrophic failure>

This is a failure mode that completely destroys the function of the capacitor such as short circuit and open circuit failure

<Wear-out failure>

This is a failure mode where the electrical parameters of the capacitor gradually deteriorate and fail. The criteria for determining if this failure has occurred depend on the purpose of a device. For each series of capacitors, the following electrical parameters have been defined as criteria in the specifications of Endurance in the catalogs or product specifications:

- Change in capacitance
- $\tan\delta$
- Leakage current

①Failure rates are often measured in units of % per 1000 hours (10^{-5} /hour). For higher reliability devices designed with a smaller failure rate, units of Failure In Time (FIT) (10_{-9} /hour) is used.

②Aluminum electrolytic capacitors are considered as components of wear-out failure mode, the electrical characteristics of which gradually deteriorate and their failure rate increases with time. In general, the failure rate in FIT is determined by total component-

TEAPO Proper Usage Methods of Liquid Aluminum Electrolytic Capacitor

hours (product of the number of tested components and test hours).
 ③ Due to the definition of FIT, the same FIT rate can be calculated in both cases of testing on the large number of tested components and also testing for long test periods of time. However, these cases mean differently for aluminum electrolytic capacitors. Using the failure rate is not suited to express the reliability of aluminum electrolytic capacitors, but the electrical characteristics based lifetime in hour should be considered to express the reliability.
 ④ Also, there are MTBF (Mean Time Between Failures) and MTTF (Mean Time To Failure) to express reliability. The latter is applicable for aluminum electrolytic capacitors because they are categorized into a group of non-repairable systems, equipment and devices for which MTTF is applicable. Failure modes depend on the application conditions that lead to fail. (Fig. 24).

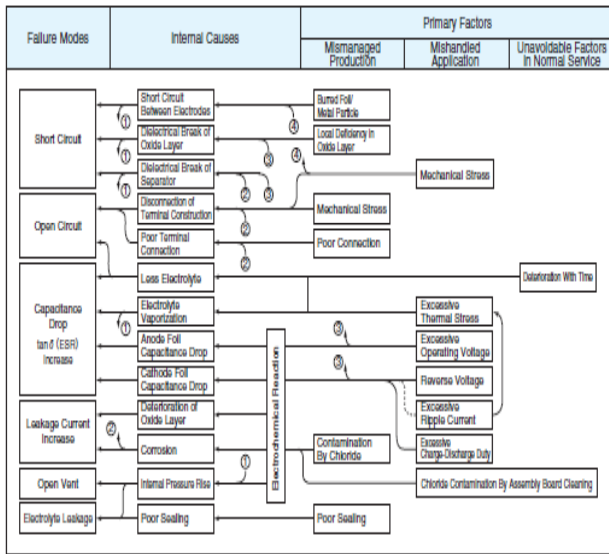

Fig-24 Failure Modes

5. Circuit Design

1) Operating Temperature, Equivalent Series Resistance(ESR), Ripple Current and Load Life

★ MTTF(Mean-Time-TO-Failure) means the useful life at room temperature 25°C.

1-1 Load life:

If the capacitor's max. operating temperature is at 105°C(85°C), then after applying capacitor's rated voltage (WV) for L₀ hours at 105°C(85°C), the capacitor shall meet the requirements in detail specification. where L₀ is called "load life" or "useful life (lifetime) at 105°C(85°C)".

$$L_x = L_0 \times 2^{(T_0 - T_x) / 10} \times K^{-\Delta T_x / 5}$$

where $\Delta T_x = \Delta T_0 \times (I_x / I_0)^2$, $I_x > I_0, K=4$; $I_x \leq I_0, K=2$

1-2 Ripple life:

If the capacitor's max. operating temperature is at 105°C(85°C), then after applying capacitor's rated voltage (WV) with the ripple current for L_r hours at 105°C(85°C), the capacitor shall meet the requirements in detail specification. where L_r is called "ripple life" or "useful ripple life(ripple lifetime) at 105°C(85°C)".

$$L_x = L_r \times 2^{(T_0 - T_x) / 10} \times K^{(\Delta T_0 - \Delta T_x) / 5}$$

where $\Delta T_x = \Delta T_0 \times (I_x / I_0)^2$, $I_x > I_0, K=4$; $I_x \leq I_0, K=2$

The (ripple) life expectancy at a lower temperature than the specified maximum temperature may be estimated by the following equation, but this expectancy formula does not apply for ambient below +40°C.
 L₀= Expected life period (hrs) at maximum operating temperature allowed.

L_r= Expected ripple life period (hrs) at maximum operating temperature allowed

L_x= Expected life period (hrs) at actual operating temperature
 T₀= Maximum operating temperature (°C) allowed
 T_x= Actual operating ambient temperature (°C)
 I_x= Actual applied ripple current (mA_{rms}) at operating frequency f₀ (Hz)

I₀= Rated maximum permissible ripple current IR(mA_{rms}) x frequency multiplier (C_f) at f₀ (Hz)

※ Ripple Current calculation: no need Temperature Multiplying Factor.

※ For Ripple life, I_x Should be 80% equal or more of I₀, if less than 80%, calculate with 80%.

△T₀ ≤ 5°C= Maximum temperature rise (°C) for applying I₀ (mA_{rms})

△T_c=Temperature rise (°C) of capacitor case for applying I_x (mA_{rms})

△T_x= Temperature rise (°C) of capacitor element for applying I_x (mA_{rms}) = K_c△T_c = K_c(T_c - T_x)

where T_c is the surface temperature (°C) of capacitor case
 T_x is ditto.

K_c= is transfer coefficient between element and case of capacitor from table below :

Φ	≤8	10	12.5/13	16	18	22	25	30	35
K _c	1.10	1.15	1.20	1.25	1.30	1.35	1.40	1.50	1.65

※ The estimated life is limited to 15 years, if it exceeds 15 years, take 15 years as standard.

★ The formula of Equivalent Series Resistance (ESR)

The operating frequency of ESR, DF, f & C must be the same, usually they test at 120 Hz.

$$ESR = DF / 2\pi f C \dots \dots \dots (2)$$

Where DF: Dissipation Factor(tanδ) f: Operating frequency(Hz)
 C: Capacitance(F)

★ Estimation of life considering the ripple current

The ripple current affects the life of a capacitor because the internal loss (ESR) generates heat. The generated heat will be:

$$P = I^2 R \dots \dots \dots (3)$$

Where I: Ripple current(A_{rms}) R: ESR(Ω)

At this time the increase in the capacitor temperature will be:

$$\Delta T = I^2 R / AH \dots \dots \dots (4)$$

Where ΔT: Temperature increase in the capacitor core(°C)

I: Ripple current(A_{rms}) R: ESR(Ω)

A: Surface area of the capacitor (cm²)

H: Radiation coefficient(Approx. 1.5~2.0 · 10⁻³ W/ cm² · °C)

The above equation (4) shows that the temperature of a capacitor increases in proportion to the square of the applied ripple current and ESR, and in inverse proportion to the surface area. Therefore, the amount of the ripple current determines the heat generation, which affects the life. The values of ΔT varies depending on the capacitor types and operating conditions. The usage is generally desirable if ΔT remains less than 5°C. The measuring point for temperature increase due to ripple current is shown below. (Fig. 25).

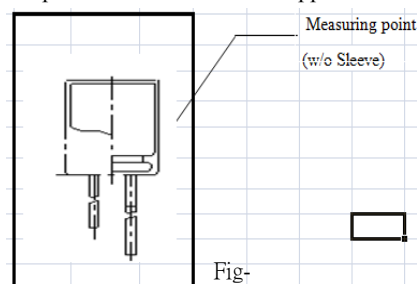

Precautions For Conductive Polymer Solid Aluminum Electrolytic Capacitor

I .Device circuits design considerations

1.Prohibited to use circuit

Conductive Polymer Solid Aluminum Electrolytic Capacitor (The following is called capacitor) may cause the leak current occur changing due to the heat stress in welding. Please avoid to use in the below circuit.

- ① High resistance voltage holding circuit.
- ② Coupled circuits.
- ③ The other circuits that affected leakage current larger

2.Circuit design

Please design circuit on the basis of confirming the following content.

- ① As the change of temperature and frequency, electric property of capacitor will changes.Please design circuit after confirming those changes.
- ② When more than 2 capacitors in parallel , please consider the balance of current when design circuit.
- ③ When more than 2 capacitors in series , as the difference of load voltage , it may load overvoltage, so please consulting us when using.
- ④ Please don't install heating components around the capacitor and the back of the printed wiring board.

3.Using capacitors for significantly safety-oriented applications

Consult us about capacitors for a device application affecting human safety (①Aviation and aerospace ②Nuclear ③Medical) or for any device whose failure will make an impact on society.

4.Polarity

Our company conductive polymer capacitor is the solid aluminum electrolytic capacitor with polarity. Never apply a reverse voltage or AC voltage. Connecting with wrong polarity will short-circuit in initial State. About polarity, please confirm product catalogue or the diagram in the product specifications.

5.Operating voltage

Do not apply an over-voltage that exceeds rated voltage, Because even if to load the voltage that more than the rated voltage only for an instant , it can also lead to increased leakage current and short-circuit. The total peak value of the ripple voltage plus the DC voltage must not exceed the rated voltage of the capacitors. In the work, it doesn't need to reduce the voltage. Although capacitors specify a surge voltage, in the temperature range, if under the rated voltage, whatever is the environment temperature; it also has limited and does not assure long-term use.

6.Ripple current

Do not apply an overcurrent that exceeds the rated ripple current specified for the capacitors. Excessive ripple current will increase heat production within the capacitors, shortening the life and short-circuit.

7.Operating temperature

If use beyond working temperature range of environment, can lead to aging and failure performance, please use in working temperature range.

8.Charging and discharging

Don not use capacitor in the circuit of rapid charge and discharge repeatedly. If capacitors are used in the circuits that repeat a charge and discharge, capacitance will decrease and/or the capacitors will be damaged by internal heat generation. When the peak of current value more that 20A, we recommend to use protect circuit in order to keep the reliability.

9.Leakage current

Sometime the leakage current will increase , but if load voltage in working temperature, it will decrease gradually though self-healing effect. In addition, the more closely to the limit temperature, the faster of the reduce speed of leakage current. The reasons for leakage current increase as below :

- ① Welding
- ② High temperature without load, high temperature and high humidity, rapid temperature change test and so on.

10.Failure mode

① Reduce the failure rate by reducing the surrounding temperature, ripple current and load voltage.

② Electrostatic capacity decreases caused by product temperature rise and opening mode wear caused by ESR rise, which are the main failure mode.

Sometimes it will occur short-circuit mode due to the overvoltage and large current.

③ Lead to short-circuit due to load the voltage that more than rated voltage, when the current is larger, the shell will expansion or peeling off, give out bad smell due to the internal pressure rising.

④ The constitute material of products containing flammable materials , the short-circuit parts will fire may due to the spark. The install ways , location , graphic design of the product, please consider the following importance points of design to ensure the absolute safety.

* Setting up protection circuit and protection devices to ensure that equipment safety.

* Setting up long circuit etc. , so that the devices will stabilization even of a single fault.

11.The insulation of the capacitor

The outer sleeve of a capacitor does not assure electrical insulation Please have electrical insulation between the capacitor sleeve and cathode terminal and anode terminal and circuit board.

12.Operating conditions

Do not use/expose capacitors to the following conditions:

- ① Direct contact with water, salt water or oil, or high condensation environment.
- ② Direct sunlight.
- ③ Toxic gases such as hydrogen sulfide, sulfurous acid, nitrous acid, chlorine and its compounds, bromine and its compounds and ammonium.
- ④ Ozone, ultraviolet rays or radiation.
- ⑤ Extreme vibration or mechanical shock that exceeds limits in the catalogs or product specifications.

13. Capacitor Mounting

① SMD product (mould SMD 、 SMD) solder graphics of the Capacitor printed wiring board, Please refer to the provisions of the catalogue or specifications for graphic design.

② For radial lead type capacitors, please make sure the terminal spacing of a capacitor equals the holes spacing on the PC board.

③ Do not print any copper trace under the seal (terminal) side of a capacitor. Copper traces should be 1 mm (preferably 2mm or more) spaced apart from the side of the capacitor body.

④ In designing a double-sided PC board, do not locate any through-hole via or unnecessary hole underneath a capacitor.

⑤ In designing a double-sided PC board, do not print any circuit pattern underneath a capacitor.

II . Installation

1.Assembling

- ① Do not try to reuse the capacitors once assembled and electrically fixed.

Precautions For Conductive Polymer Solid Aluminum Electrolytic Capacitor

- ② Capacitors may have been spontaneously recharged with time by a recovery voltage phenomenon. In this case, discharge the capacitors through a resistor of approximately 1kΩ before use.
- ③ If non-solid aluminum electrolytic capacitors have been stored at any conditions more than 35°C and 75%RH for long storage periods of time more than the limits specified in the catalogs or product specifications, they may have high leakage current. In this case, discharge by apply-ing the rated voltage through a resistor of approximately 1kΩ.
- ④ Confirm the rated capacitance and voltage of capacitors before installation.
- ⑤ Confirm the polarity of capacitors before installation.
- ⑥ Do not try to use the capacitors that were dropped to the floor and so forth.
- ⑦ Do not deform the can case of a capacitor.
- ⑧ Make sure that the terminal spacing of a capacitor equals the holes spacing on the PC board before installing the capacitor.
- ⑨ Do not apply excessive mechanical force to capacitors more than the limits prescribed in the catalogs or product specifications. If apply excessive force, the terminal will break off or deformation and affect install, even cause short-circuit, break line, increase LC and damage package. Avoid excessive mechanical force while the capacitors are in the process of vacuum-picking, placing and positioning by automatic mounting machines or cutting the lead wires by automatic insertion machines.

2. Soldering and heat resistance

Ensure that the soldering conditions meet the specifications recommended by Nippon Chemi-Con. Note that the leakage current may increase or capacitance may decrease due to thermal stresses that occur during soldering, etc. Furthermore, the leakage current which rose gradually decreases, when voltage is applied at below the category upper limit temperature. Additionally the self repairing action is faster when voltage near the rated voltage rather than at a higher voltage is applied at below the category's upper temperature limit.

1) Verify the following before using a soldering iron:

- ① That the soldering conditions (temperature and time) are within the ranges specified in the catalog or product specifications.
- ② That the tip of the soldering iron does not come into contact with the capacitor itself.

2) Verify the following when flow soldering:

- ① Do not dip the body of a capacitor into the solder bath only dip the terminals in. The soldering must be done on the reverse side of PC board.
- ② Soldering conditions should be within the limits prescribed in the catalog or the product specifications.
- ③ Do not apply flux to any part of capacitors other than their terminals.
- ④ Make sure the capacitors do not come into contact with any other components while soldering.

Please note the SMD product (SMD type) non-corresponding wave-soldering.

3) Verify the following when reflow soldering:

- ① Soldering conditions (preheat, solder temperature and soldering time) should be within the limits prescribed in the catalogs or the product specification.
- ② The heat level should be appropriate. (Note that the thermal stress on the capacitor varies depending on the type and position of the heater in the reflow oven, and the color and material of the capacitor.)

Except for the surface mount type, reflow soldering must not be used for the other capacitors.

4) Do not reuse a capacitor that has already been soldered to PC board and then removed. When using a new capacitor in the same location, remove the flux, etc. first, and then use a soldering iron to solder on the new capacitor in accordance with the specifications.

3. Handling After Soldering

Do not apply any mechanical stress to the capacitor after soldering onto the PC board.

- ① Do not lean or twist the body of the capacitor after soldering the capacitors onto the PC board.
- ② Do not use the capacitors for lifting or carrying the assembly board.
- ③ Do not hit or poke the capacitor after soldering to PC board. When stacking the assembly board, be careful that other components do not touch the aluminum electrolytic capacitors.
- ④ Do not drop the assembled board.

4. Cleaning PC boards

1) Do not wash capacitors by using the following cleaning agents. Solvent resistant capacitors are only suitable for washing using the cleaning conditions prescribed in the catalog or the product specification. In particular, ultrasonic cleaning will accelerate damage to capacitors.

- * Halogenated solvents → cause capacitors to fail due to corrosion.
- * Alkali system solvents → corrode (dissolve) an aluminum case.
- * Petroleum system solvents → cause the rubber seal material to deteriorate.
- * Xylene → causes the rubber seal material to deteriorate
- * Acetone → erases the markings

CFC alternatives or the other cleaners above; please consult with us.

2) Verify the following points when washing capacitors.

- ① Monitor conductivity, pH, specific gravity and the water content of cleaning agents. Contamination adversely affects these characteristics.
- ② Be sure not to expose the capacitors under solvent rich conditions or keep capacitors inside a closed container.

In addition, please dry the solvent sufficiently on the PC board and the capacitor with an air knife (temperature should be less than the maximum rated category temperature of the capacitor) for 10 minutes. Aluminum electrolytic capacitors can be characteristically and catastrophically damaged by halogen ions, particularly by chlorine ions, though the degree of the damage mainly depends upon the characteristics of the electrolyte and rubber seal material. When halogen ions come into contact with the capacitors, the foil corrodes when a voltage is applied. This corrosion causes an extremely high leakage current which results venting and an open circuit.

3) Verify the following when reflow soldering:

① Higher alcohol cleaning agents.

Using these cleaning agents, capacitors are capable of with-standing immersion or ultrasonic cleaning for 10 minutes at a maximum liquid temperature of 60°C. Find optimum condition for washing, rinsing, and drying. Be sure not to rub the marking off the capacitor which can be caused by contact with other components or the PC board. Note that shower cleaning adversely affects the markings on the sleeve.

② Non-Halogenated Solvent Cleaning.

Immersion, ultrasonic or vapor cleaning for 5 minutes. However, from an environmental point of view, these types of solvent will be banned in near future. We would recommend not using them if at all possible.

③ Isopropyl Alcohol (IPA).

IPA (Isopropyl Alcohol) is one of the most acceptable cleaning agents; it is necessary to maintain a flux content in the cleaning liquid at a maximum limit of 2 Wt.%.)

Precautions For Conductive Polymer Solid Aluminum Electrolytic Capacitor

5. Precautions for using adhesives and coating materials

- 1) Do not use any adhesive and coating materials containing.
- 2) Verify the following before using adhesive and coating material.
 - ① Remove flux and dust left over between the rubber seal and the PC board before applying adhesive or coating materials to the capacitor.
 - ② Dry and remove any residual cleaning agents before applying adhesive and coating materials to the capacitors. Do not cover over the whole surface of the rubber seal with the adhesive or coating materials.
 - ③ For permissible heat conditions for curing adhesives or coating materials, please consult with us.
 - ④ Covering over the whole surface of the capacitor rubber seal with resin may result in a hazardous condition because the inside pressure cannot be completely released. Also, a large amount of halogen ions in resins will cause the capacitors to fail because the halogen ions penetrate into the rubber seal and the inside of the capacitor.
 - ⑤ Some coating materials, it cannot be implemented to the capacitor.

6. Fumigation

In many cases when exporting or importing electronic devices, such as capacitors, wooden packaging is used. In order to control insects it may become necessary to fumigate the shipment. Precautions during "Fumigation" using halogenated chemical such as Methyl Bromide must be taken. Halogen gas can penetrate packaging materials such as cardboard boxes and vinyl bags. Penetration of the halogenated gas can cause corrosion of Electrolytic capacitors. Nippon Chemi-Con gives consideration to the packaging materials not to require the Fumigation. Verify whether the assembled PC board, products and capacitors themselves are subjected to Fumigation during their transportation or not.

III. The Operation of Devices

1. Do not touch the capacitor terminals directly.

2. Do not short-circuit the terminal of a capacitor by letting it come into contact with any conductive object.

Also, do not spill electric-conductive liquid such as acid or alkaline solution over the capacitor.

3. Please make sure the assembly of the complete circuit of capacitor installation environment.

Do not use capacitors in circumstances where they would be subject to exposure to the following materials

- ① Oil, water, salty water or damp location.
- ② Direct sunlight.
- ③ Ozone, ultraviolet rays or radiation.
- ④ Toxic gases such as hydrogen sulfide, sulfurous acid, nitrous acid, chlorine or its compounds, and ammonium.
- ⑤ Severe vibration or mechanical shock conditions beyond the limits prescribed in the catalog or product specification.

IV. Maintenance Inspection

1. Make periodic inspections of capacitors that have been used in industrial applications.

Before inspection, turn off the power supply and carefully discharge the electricity in the capacitors. Verify the polarity when measuring the capacitors with a volt-ohm meter. Do not apply any mechanical stress to the terminals of the capacitors.

2. The following items should be checked during the periodic inspections.

- ① Significant damage in appearance.
- ② Electrical characteristics: leakage current, capacitance, $\tan\delta$ and other characteristics prescribed in the catalog or product specification.

We recommend replacing the capacitors if the parts are out of specification.

V. Contingencies

- 1) If gas has vented from the capacitor during use, there is a short circuit and burning, or the capacitor discharges an odor or smoke, turn off the main power supply to the equipment or unplug the power cord.
- 2) If there is a problem with the capacitor or a fire breaks out, the capacitor may produce a burning gas or reactive gas from the outer resin, etc. If this happens, keep your hands and face away from the gas. If vented gas is inhaled or comes into contact with your eyes, flush your eyes immediately with water and/or gargle. If vented gas comes into contact with the skin, wash the affected area thoroughly with soap and water.

VI. Storage

We recommend the following conditions for storage.

- 1) Store capacitors in a cool, dry place. Store at a temperature between 5 and 35°C, with a humidity of 75% or less. (table-1 Maximum storage term)

The duration, please refer to the table below.

	Before the bag is opened	After the bag is opened
SMD (Resin-Molded chip type)	within six months after delivery	Within 30 days after the bag is opened
Radial lead type	within one year after delivery	Within 7 days after the bag is opened

- ① SMD products are sealed in a PE plastic bag. Use all capacitors in desposit period once the bag is opened.
- ② If the bag have open and need to storage, please return unused capacitors to the bag, and seal it with a zipper.
- ③ Be sure to follow our recommendations for reflow soldering.
- 2) Store the capacitors in a location free from direct contact with water, salt water, and oil.
- 3) Store in a location where the capacitor is not exposed to toxic gas, such as hydrogen sulfide, sulfurous acid, nitrous acid, chlorine or chlorine compounds, bromine or other halogen gases, methyl bromide or other halogen compounds, ammonia, or similar.
- 4) Store in a location where the capacitor is not exposed to ozone, ultraviolet radiation, or other radiation.
- 5) It is recommended to store capacitors in their original packaging wherever possible.

VII. Disposal

Please consult with a local industrial waste disposal specialist when disposing of aluminum electrolytic capacitors.

VIII. Regarding compliance for EU REACH Regulation

- 1) According to the content of REACH handbook (Guidance on requirements for substances in articles which is published on May 2008), our electronic components are "articles without any intended release". Therefore they are not applicable for "Registration" for EU REACH Regulation Article 7 (1).
Reference: Electrolytic Condenser Investigation Society: "Study of REACH Regulation in EU about Electrolytic Capacitor" (publicized on 13 March 2008)
- 2) Nippon Chemi-Con develops the products without substance of very high concern (SVHC).

IX. Catalogs

Specifications in the catalogs are subject to change without notice. Test data shown in the catalogs are not assured as the whole performance values, but typical values.

Precautions in Using(Non-Solid Aluminum Electrolytic Capacitor)

I .Device circuits design considerations

1. Confirm installation and operating requirements for capacitors, then use them within the performance limits prescribed in this catalog or product specifications.

2. Polarity

Aluminum electrolytic capacitors are polariz

Never apply a reverse voltage or AC voltage. Connecting with wrong polarity will short-circuit or damage the capacitor with the pressure relief vent opening early on. To identify the polarity of a capacitor, see the relevant diagram in the catalogs or product specifications, or the polarity marking on the body of the capacitor. Incidentally, the rubber end seal bungs of the radial lead type capacitors have a solder-flux gas escaping configuration, which is nothing to do with the polarity of the capacitors. For circuits where the polarity is occasionally reversed, use a bi-polar type of aluminum electrolytic capacitor. However, note that even bi-polar type capacitors must not be used for AC circuits.

3. Operating voltage

Do not apply an over-voltage that exceeds a rated voltage specified for the capacitors. The total peak value of the ripple voltage plus the DC voltage must not exceed the rated voltage of the capacitors. Although capacitors specify a surge voltage that exceeds the full rated voltage, it does not assure long-term use but limited use under specific conditions.

4. Ripple current

Do not apply an overcurrent that exceeds the rated ripple current specified for the capacitors. Excessive ripple current will increase heat production within the capacitors, causing the capacitors to be damaged as follows:

- Shorten lifetime
- Open pressure relief vent
- Short circuit

The rated ripple current is specified along with a specific ripple frequency. Where using the capacitors at any other ripple frequency other specified frequency, calculate the allowable ripple current by multiplying the rated ripple current by a frequency compensation factor(Frequency Multiplier) specified for each product series.

5. Operating temperature (Category temperature)

Do not apply high temperatures that exceed the upper limit of the category temperature range specified for the capacitors. Using the capacitor at temperatures higher than the upper limit will considerably shorten the lifetime of the capacitor and make the pressure relief vent open.

In other words, lowering ambient temperatures will extend the expected lifetime of the capacitors.

6) Lifetime

Select the capacitors to meet the service life requirements of a device

7) Charging and discharging

Do not use capacitors in circuits intended for rapid charge and discharge cycle operations.

If capacitors are used in the circuits that repeat a charge and discharge with a large voltage drop or a rapid charge and discharge at a short interval cycle, capacitance will decrease and/or the capacitors will be damaged by internal heat generation.

Consult us for a heavy charge and discharge type of capacitor so that the capacitor will be designed in accordance with requirements of duty

cycle of charge and discharge, the number of cycles, discharging resistance and operating temperatures.

8. Failure mode of capacitors

Non-solid aluminum electrolytic capacitors have a limited lifetime which ends in an open circuit failure mode, in general. Depending on the product type and operating conditions, the failure mode may involve in opening of the pressure relief vent.

9. Capacitor insulation

Electrically isolate the following sections of a capacitor from the negative terminal, the positive terminal and the circuit patterns.

- The outer can case of a non-solid aluminum capacitor.
- The dummy terminal of a snap-in type non-solid aluminum capacitor, which is designed for mounting stability.

10. Outer sleeve

The outer sleeve of a capacitor does not assure electrical insulation (except for screw-terminal type capacitors). It should not be used where electrical insulation is required.

11. Operating conditions

Do not use/expose capacitors to the following conditions:

- ① Direct contact with water, salt water or oil, or high condensation environment.
- ② Direct sunlight.
- ③ Toxic gases such as hydrogen sulfide, sulfurous acid, nitrous acid, chlorine and its compounds, bromine and its compounds and ammonium.
- ④ Ozone, ultraviolet rays or radiation.
- ⑤ Extreme vibration or mechanical shock that exceeds limits in the catalogs or product specifications.

The standard vibration condition is applicable to JIS C 5101-4.

12. Mounting

① Non-solid aluminum electrolytic capacitors contain paper separators and electric-conductive electrolyte that contains organic solvent as main solvent material, both of which are flammable. If the electrolyte leaks onto a printed circuit board, it can erode the device circuit pattern, may short-circuit the copper traces, smoke and burn. Make sure of designing a PC board as follows:

- Provide the appropriate hole spacing on the PC board to match the terminal spacing of a capacitor.
- Provide the following adequate clearance space over the pressure relief vent of a capacitor to avoid blocking the correct opening of the pressure relief vent.

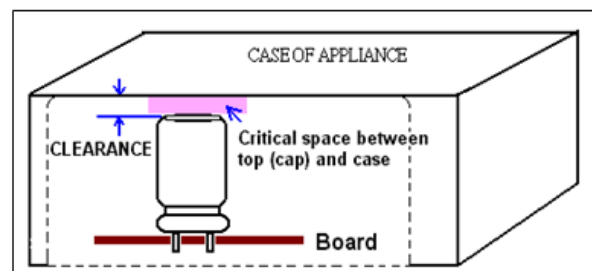

Case diameter	Clearance
Φ6.3 to Φ16 mm	≥ 2 mm
Φ18 to Φ 35 mm	≥ 3 mm
Φ40 mm & 以上	≥ 5 mm

- Do not locate any wire or circuit pattern over the pressure relief vent of a capacitor.
- If a capacitor is mounted with its pressure relief vent facing down on the PC board, provide a ventilation hole in the board beneath it to let gas escape when the vent opens.
- Do not print any copper trace under the seal (terminal) side of a capacitor. Copper traces should be 1 mm (preferably 2mm or more) spaced apart from the side of the capacitor body.
- Avoid locating any heat source components near capacitors or on the opposite side of the PC board under capacitors.
- In designing a double-sided PC board, do not locate any through-hole via or unnecessary hole underneath a capacitor.
- In designing a double-sided PC board, do not print any circuit pattern underneath a capacitor.

② For a screw terminal type capacitor, tightening the terminal screw and the mounting clamp should be within the maximum torque specified in the catalogs or product specifications. Do not mount a screw terminal type capacitor with the terminals facing downward. Also, if the body of a capacitor is installed horizontally such as being laid on its side, do not position the pressure relief vent downward.

③ For a chip type capacitor, design the land patterns of the PC board accordance with the recommended footprint dimensions described in the catalogs or product specifications

13. Using capacitors for significantly safety-oriented applications

Consult us about capacitors for a device application affecting human safety (①Aviation and aerospace ②Nuclear ③Medical ④) or for any device whose failure will make an impact on society. Note that some products such as photoflash use capacitors which have been designed for specific applications cannot be used for any other application

14. Others

Design device circuits taking into consideration the following conditions

- ① Electrical characteristics of a capacitor depend on the temperature and frequency. In designing the device circuits, consider the change in the characteristics.
- ② If using more than one capacitor connected in parallel, design the device circuits to balance the current flow in individual capacitors.
- ③ If using more than one capacitor connected in series, connect shunting resistors in parallel with the individual capacitors to balance the voltage.

II. Installation

1. Assembling

- ① Do not try to reuse the capacitors once assembled and electrified, except only capacitors that are taken from a device for periodic inspection to measure their electrical characteristics.
- ② Capacitors may have been spontaneously recharged with time recovery phenomenon. In this case, through a resistor of approximately 1kΩ before use.
- ③ If non-solid aluminum electrolytic capacitors have been stored at any conditions more than 35°C and 75%RH for long storage periods of time more limits specified in catalogs or product specifications, they may current. In this case, make pre-conditioning by applying the rated voltage through a resistor of approximately 1kΩ.
- ④ Confirm the rated capacitance and voltage of capacitors before installation.
- ⑤ Confirm the polarity of capacitors before installation.

⑥ Do not try to use the capacitors that were dropped to the floor and so forth.

⑦ Do not deform the can case of a capacitor.

⑧ Make sure that the terminal spacing of a capacitor equals the holes spacing on the PC board before installing the capacitor. For radial lead type capacitors, some standard pre-formed lead types are also available.

⑨ When installing a snap-in type capacitor on the PC board insert the terminals into the holes and press the capacitor down until the body is settled flush on the surface of the PC board (without the body standing off).

⑩ Do not apply excessive mechanical force to capacitors more than the limits prescribed in the catalogs or product specifications. Avoid excessive mechanical force while the capacitors are in the process of vacuum-picking, placing and positioning by automatic mounting machines or cutting the lead wires by automatic insertion machines.

2. Soldering and heat resistance

① For soldering using a soldering iron, consider the following conditions:

- Soldering conditions (temperature and time) should be within the limits prescribed in the catalogs or product specifications.

- If it is necessary to pre-form the terminal spacing of a capacitor to match the hole spacing on the PC board before assembly and soldering, do not make mechanical stress reach into the body of the capacitor but only the lead wires.

- Do not touch the body of a capacitor with the hot tip of the soldering iron.

② For flow soldering, consider the following conditions:

- Do not dip the body of a capacitor into a solder bath. Expose only the terminals to the melt solder with the PC board interposing between the solder and the body of the capacitor. Solder only the reverse side of the PC board where the body of the capacitor is not located.

- Soldering conditions should be within the limits prescribed in the catalogs or product specifications.

- Do not apply flux to any part of a capacitor other than the terminals.

- Do not let any other component lean against nor come into contact with the capacitor while soldering.

③ For reflow soldering, consider the following conditions:

- Soldering conditions (preheat, reflow temperature and time) should be within the limits prescribed in the catalogs or product specifications.

- When using the infrared heater and setting its temperatures, adjust the heating levels taking into consideration that the color and materials of a capacitor vary in their infrared absorbance.

- The allowable number of reflow passes is specified in the catalogs or product specifications.

- When mounting a capacitor on the double-sided PC board, do not place any wiring pattern underneath the capacitor.

- Please consult us about vapor phase soldering (VPS).

④ Do not try to reuse the capacitor that was removed from the PC board after soldering.

⑤ Only use chip type capacitors for reflow soldering. The other type capacitors are not designed for the reflow.

3. Handling after soldering

After soldering the PC board, do not apply the following mechanical stress to the capacitor:

- ① Do not tilt, push down or twist the body of the capacitor.
- ② Do not grab the body of the capacitor to carry the assembly
- ③ Do not hit anything against the capacitor. When stacking the assembled boards, do not put any of the PC boards or other components against the capacitor.
- ④ Do not drop the assembled board.

4. Cleaning assembly boards

- ① Do not clean capacitors with the following cleaning agents:
 - Halogenated solvents: cause capacitor failures due to corrosion.
 - Alkali system solvents: corrode (dissolve) the aluminum can case.
 - Terpene and petroleum system solvents: deteriorate the rubber seal materials.

- Xylene: deteriorates the rubber seal materials as well.
- Acetone: erases the markings printed on a capacitor.

Where cleaning is necessary, use only solvent resistant type that have been assured for the cleaning within the specific conditions prescriber in the catalogs or product specifications.

In particular, carefully set up the conditions for ultrasonic cleaning system.

- ② Where cleaning the solvent resistance type of aluminum electrolytic capacitors, confirm the following conditions:

- Control the contamination (the conductivity, pH, specific gravity, water content, etc.) of the cleaning agents.

- After the cleaning, do not leave the capacitors (assembly boards) an environment of cleaning agent-rich or in a closed container. Sufficiently evaporate the residual cleaning agent from the boards and the capacitors by forced hot air at temperatures less than the upper limit of category temperature range for more than 10

In general, aluminum electrolytic capacitors are sensitive to contamination of halogen ions (particularly to chlorine on the properties of the electrolyte and rubber seal materials used capacitor, the halogen ions lead up to catastrophic failures on the capacitor. Where the inside of a capacitor has been contaminated with more than a certain amount of halogen ions and the capacitor use, the corrosion reaction of aluminum occurs. The corrosion the capacitor to have a significant increase in leakage current with heat produced, open the pressure relief vent and become open. Due to global environmental issues (greenhouse effects and other environmental destruction by depletion of the ozone layer), the conventional cleaning solvents of CFC113, Trichloroethylene and 1,1,1-trichloroethylene were replaced by substitutes.

The following are some substitute cleaning agents and allowable cleaning conditions:

- a) Fatty-alcohol cleaning agents

Pine Alpha ST-100S (Arakawa Chemical)

Clean Through 750H, 750K, 750L and 710M (Kao)

Technocare FRW-14, 15, 16 and 17 (Momentive Performance Materials)

[Cleaning conditions]

Either of immersion or ultrasonic cleaning, for a maximum of 10 and at a maximum liquid temperature of 60°C is acceptable. Make that the markings on the capacitor are not rubbed against any other component or the PC board during cleaning. Note that shower cleaning affects the markings on the capacitor.

- b) HCFC (Freon 225) as Alternative CFCs

AK225AES (Asahi Glass)

[Cleaning conditions]

Solvent resistant type capacitors, which were originally developed to intend to resist Freon TE or Freon TES, are also capable of withstanding any one of immersion, ultrasonic or vapor cleaning, for a maximum of 5 minutes (or 2 minutes for KRE and KRE-BP series capacitors or 3 minutes for SRM series). However, this type of cleaning agent is not recommended to use, as the cleaning materials may be banned in near future in view of global environmental issues.

- c) IPA (Isopropyl Alcohol)

Immersion cleaning with a maximum flux concentration of 2 wt% is acceptable.

5. Adhesives and coating materials

- ① Do not use any adhesive or coating materials containing halogenated solvents.
- ② Make sure of the following conditions before applying adhesive or coating materials to a capacitor,
 - No flux residue nor stain is left between the rubber seal of a capacitor and PC board.
 - Dry the capacitor to remove residual cleaning agents before applying adhesive and coating materials. Do not cover up the entire surface of the rubber seal of the capacitor with adhesives or coating materials.
 - Heating and curing conditions for adhesives and coating materials should be followed as prescribed in the catalogs or product specifications.
 - Covering up the entire surface of the rubber seal with resin mold materials will obstruct the normal diffusion of internal hydrogen gas from a capacitor and result in serious failures. Also, where the adhesive and coating materials contain a large amount of halogen ions, the halogen ions will contaminate the inside of the capacitor through the rubber seal materials, causing the capacitor to become a failure.
 - Depending on solvent materials that the adhesive or coating materials contains, note that the outer sleeve of a capacitor may lose a gloss or whiten in appearance.

6. Fumigation

In exporting or importing electronic devices, they may be exposed to fumigation with halide such as methyl bromide. Where aluminum electrolytic capacitors are exposed to halide such as methyl bromide, the capacitors will be damaged with the corrosion reaction with halogen ions in the same way as cleaning agents. For the export and import, Nippon Chemi-Con considers using some packaging method and so forth so that fumigation is not required. For customers to export or import electronic devices, semi-assembly products or capacitor components, confirm if they will be exposed to fumigation and also consider final condition of packaging. (Note that either cardboard or vinyl package has a risk of fumigation gas penetration.)

III. Precautions during operation of devices

1. Never touch the terminals of a capacitor directly with bare hands.
2. Do not short-circuit between the capacitor terminals with anything conductive. Also, do not spill any conductive liquid such as acid or alkaline solution over a capacitor.

- 3 . Confirm environmental conditions where the device will be placed. Do not use the device in the following environmental
- ① Water or oil spatters, or high condensation environment
 - ② Direct sunlight.
 - ③ Ozone, ultraviolet rays or radiation.
 - ④ Toxic gases such as hydrogen sulfide, sulfuric acid, nitrous acid, chlorine and its compounds, bromine and its compounds and
 - ⑤ Severe vibration or mechanical shock conditions beyond the limits prescribed in the catalog or product specification.
- The standard vibration condition is applicable to JIS C 5101-4.

IV.Maintenance inspections

- 1 . For industrial use capacitors, make periodic inspections the
Before the inspections, turn off the power supply of the device and discharge the electricity of the capacitors. When checking it by a ohm meter, confirm the polarity beforehand. Do not apply stress to the terminals of the capacitors during inspection.
- 2 . Characteristics to be inspected
 - ① Significant damage in appearance: vent opening, electro-lyte etc.
 - ② Electrical characteristics: leakage current, capacitance, $\tan\delta$ and other characteristics prescribed in the catalogs or productIf finding anything abnormal on the characteristics above, check the specifications of the capacitor and take appropriate actions such as replacement.

V.Capacitor venting

- 1 . A capacitor with more than a certain case size has the pressure relief vent functioning to escape abnormal gas pressure increase. If gas expels from a venting capacitor, disconnect the power supply of the device or unplug the power supply cord. If not disconnecting the power supply, the device circuit may be damaged due to the short circuit failure of the capacitor or short-circuited with the liquid that the gas was condensed to. It may cause secondary damages such as device burnout in the worst case scenario.
The gas that comes out of the open vent is vaporized electro-lyte, smoke.

- 2 . The gas expelled from a venting capacitor is more than 100°C. Never expose your face to the capacitor. If your eyes are exposed to the gas or you inhale it, immediately flush your eyes and/or gargle with water. If the electrolyte comes in contact with the skin, wash with soap and water.

VI.Storage

- 1 . Do not store capacitors at high temperature or high humidity. Store the capacitors indoors at temperatures of 5 to 35°C and humidities of less than 75%RH.
In principle, aluminum electrolytic capacitors should be used within three years after production.
- 2 . Keep capacitors packed in the original packaging material wherever possible.
- 3 . Avoid the following storage environmental conditions:
 - ① Water spattering, high temperatures, high humidity or condensation environment.
 - ② Oil spattering or oil mist filled.
 - ③ Salt water spattering or salt filled.
 - ④ Acidic toxic gases such as hydrogen sulfide, sulfuric acid, nitrous acid, chlorine, bromine and methyl bromide filled.
 - ⑤ Alkaline toxic gases such as ammonium filled.
 - ⑥ Acid or alkaline solutions spattering.
 - ⑦ Direct sunlight, ozone, ultraviolet rays or radiation.
 - ⑧ Extreme vibration or shock loading.
- 4 . JEDEC J-STD-020 is not applicable.

VII.Capacitor disposal

Please consult with a local organization for the proper disposal of industrial waste. For incinerating capacitors, apply a high-temperature incineration (over 800°C). Incinerating them at temperatures lower than that may produce toxic gases such as chlorine. To prevent capacitors from explosion, punch holes in or sufficiently crush the can cases of the capacitors, then incinerate.